

Tiny 2040 (PIM558)

USB-C connector

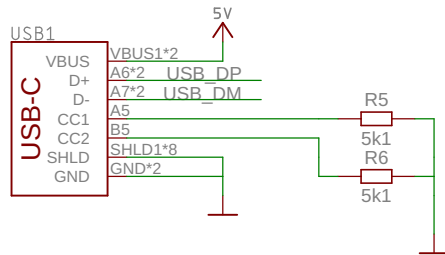

RGB LED

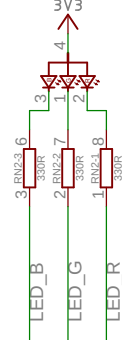

RP2040 MCU

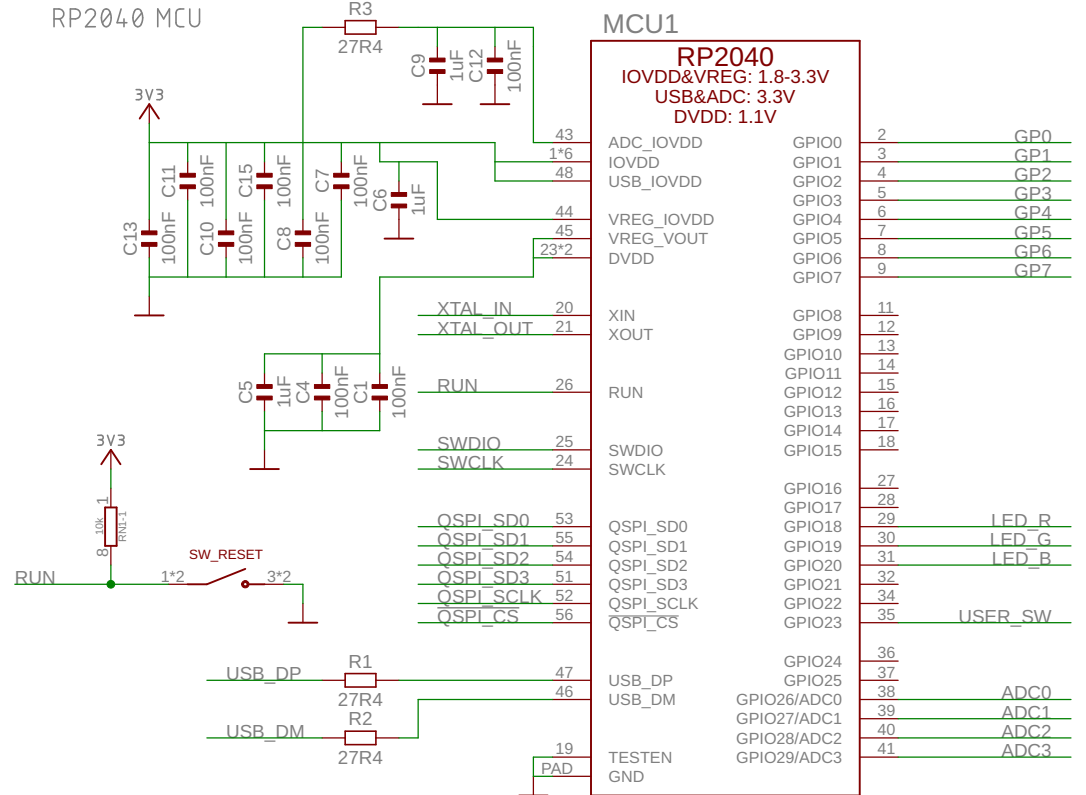

LDO

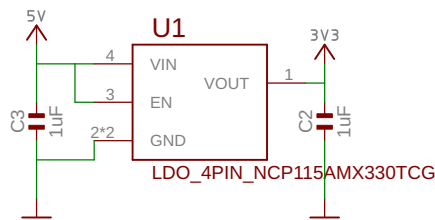

Debug pads

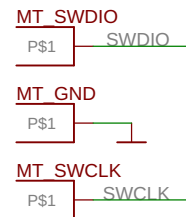

Output headers

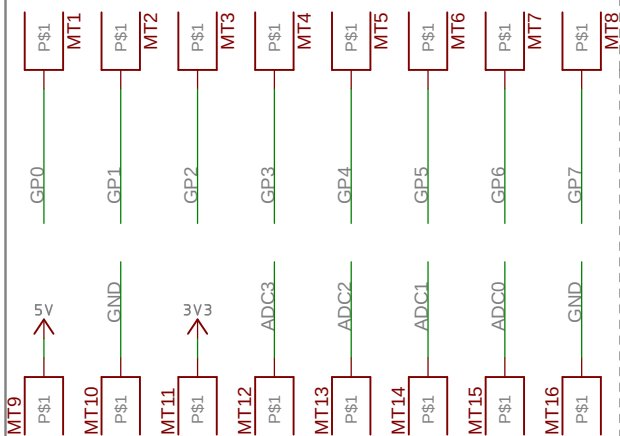

Crystal oscillator

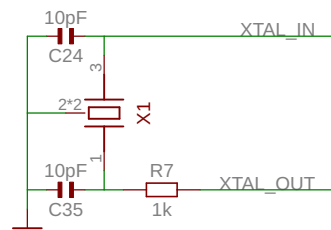

Flash memory, 8MB

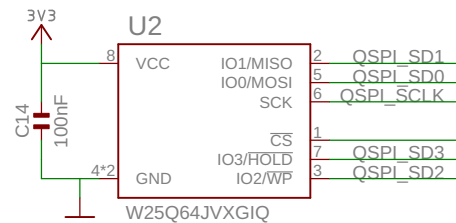

Combined USB boot & user switch

